

Space-saving Sensor Amplifier reliably detects a wide variety of liquids ranging from water to chemical liquids with low conductivity

- Detects leakage of liquid such as isopropyl alcohol by monitoring the resistance between sensing bands
- Detects liquids with impedance as high as 50 MΩ
- Four selectable sensing ranges ensure detection suited to the characteristics of the liquid
- Incorporates a noise canceller circuit connected to a 3-conductor cable, ensuring a high level of noise immunity and reliable operation (Patent pending)
- Sends AC signals to the Sensing Band, preventing electric corrosion
- CE and UL/CSA approval



## Ordering Information

Item	Part number	Material
Liquid Leakage Sensor Amplifier	<b>K7L-AT50</b>	---
Sensing Band	<b>F03-16PE</b>	Sheath: Polyethylene Core: Stainless steel SUS316
Sensing Band Sticker with Adhesive	<b>F03-26PE</b>	Polyethylene
Sensing Band Sticker without Adhesive	<b>F03-26PEN</b>	Polyethylene
Terminal Block	<b>F03-20</b>	---
Track-mounted Socket	<b>P2RF-08-E</b>	---
	<b>P2RF-08</b>	---

- Note: 1. One piece of the F03-20 Terminal Block is included as an accessory with the K7L-AT50.
2. F03-16PE Sensing Bands are available in 1 m, 2 m, 5 m, 10 m, 15 m, 20 m, 25 m, and 50 m as standard lengths. For example, if a 4-m-long F03-16PE Sensing Band is required, place an order for F03-16PE 5M (5 m in length). If you need a 12-m-long F03-16PE Sensing Band, place an order for F03-16PE 15M (15 m in length).
3. The minimum order quantity of the F03-26PE or F03-26PEN Sensing Band Sticker is one set (containing 30 pieces).
4. The minimum order quantity of the F03-20 Terminal Block is one set (containing 10 pieces).

## Specifications

### ■ RATINGS

Rated power supply voltage	12 to 24 VDC (Allowable voltage fluctuation range: 10 to 30 VDC)
Operate resistance	0 $\Omega$ to 50 M $\Omega$ , variable Range 0: 0 to 250 k $\Omega$ Range 1: 0 to 600 k $\Omega$ Range 2: 0 to 5 M $\Omega$ Range 3: 0 to 50 M $\Omega$ <b>Note:</b> Set pins 1, 2, or 3 of the DIP switch on the side of the Sensor Amplifier to the upwards position according to the range to be selected. These pins, which are arranged in numerical order from left to right, correspond to ranges 1 through 3. Be sure to set only the corresponding pin to the upward position. For range 0, set all these switches downwards. The adjuster (ADJUST) on the front panel allows resistance changes from 0 $\Omega$ to the upper limit of the set range. The adjuster is set to the upper limit as default. (Normally, the adjuster should be set to the upper limit.)
Release resistance	105% min. of operate resistance
Output configuration	NPN open collector transistor output with 100 mA at 30 VDC max. <b>Note:</b> For output OFF when liquid leakage is detected: Set pin 4 of the DIP switch located on the side of the Sensor Amplifier in the down position. For output ON when liquid leakage is detected: Set pin 4 of the DIP switch located on the side of the Sensor Amplifier in the up position.
Wiring distance	Wiring cable: 50 m max. Sensing Band length: 10 m max. <b>Note:</b> These values are possible on condition that a completely insulated 3-conductor VCT cable with a thickness of 0.75 mm <sup>2</sup> and a dielectric strength of 600 V is used together with a Liquid Sensing Band specified by OMRON. (A 0.2-mm <sup>2</sup> cable can also be used.)
Accessories	Terminal block (for connecting wiring cable and Sensing Band) Screwdriver for ADJUST setting. (Purchase the Sensing Band, Sensing Band Sticker, wiring cable, and Socket separately.)

### ■ CHARACTERISTICS

Ambient temperature	Operating: -10°C to 55°C Storage: -25°C to 65°C (with no icing or condensation)
Ambient humidity	Operating: 45% to 85% Storage: 25% to 85% (with no icing or condensation)
Insulation resistance	10 M $\Omega$ at 100 VDC between case and current-carrying parts
Dielectric strength	1,000 VAC at 50/60 Hz for 1 min between case and current-carrying parts
Power consumption	1 VA max.
Response time	Operate: 800 ms max. Release: 800 ms max.
Weight	Approx. 14 g

## Application Examples

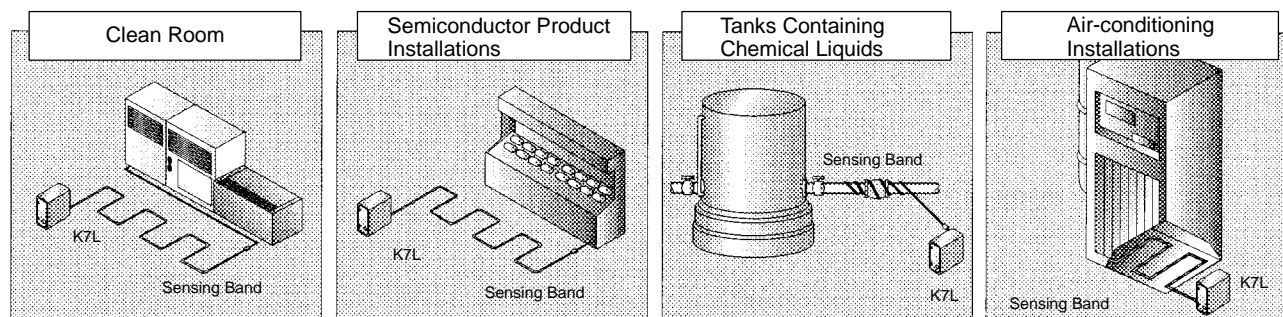

## Nomenclature

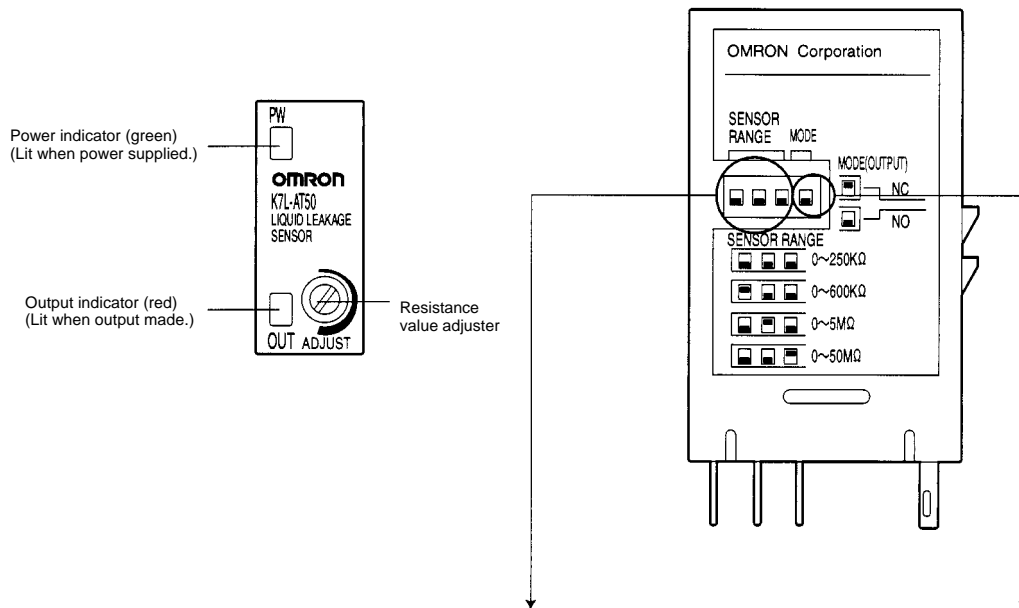

### ■ DIP SWITCH SETTINGS

#### Setting Detection Range

DIP switch	Range number	Detection range
	Range 0	0 to 250 kΩ
	Range 1	0 to 600 kΩ
	Range 2	0 to 5 MΩ
	Range 3	0 to 50 MΩ

DIP switch	Output
	Output OFF when liquid leakage detected.
	Output ON when liquid leakage detected.

- Set a detection range according to the impedance of the liquid to be detected. (If the detection range DIP switches are set in a way not shown above, the actual range used will be the largest one by default.) For the setting procedure, either refer to the label on the side of the Sensor Amplifier.
- It is possible to set the resistance value within the set detection range using the resistance value adjuster. At time of delivery, it is set to the largest possible value and for normal use this setting can be used.
- The resistance value adjuster is a precision component. Do not apply a torque to the resistance value adjuster in excess of the specified one. Doing so may cause the resistance value adjuster to be damaged.  
Applicable torque:
  - Rotational torque: 9.81 mN•m (100 gf•cm) max.
  - Detent strength: 29.4 mN•m (300 gf•cm) min.

## Operation

### ■ COUNTERMEASURES AGAINST NOISE

#### Noise Canceller Function for Highly Sensitive Impedance Detection

The K7L Liquid Leakage Sensor Amplifier detects liquids with impedance as high as 50 MΩ and connects to the Sensing Band through a cable that can be extended up to 50 meters. Countermeasures against external noise are especially important for the Sensing Band and connecting cable because they pick up external noise like an antenna. The K7L incorporates a noise canceller function as described below.

#### Connected with 3-conductor Cable that Offsets Inductive Noise (Patent Pending)

A VCT cable with three conductors (lines) is used. Line 1 is connected to the Sensing Band and line 2 is left open. Lines 1 and 2 are almost in the same position and thus will experience the same noise level. The K7L obtains the difference between these signals. This means that the noise signals in lines 1 and 2 are offset against each other and a reading for the signal, without inductive noise, can be made.

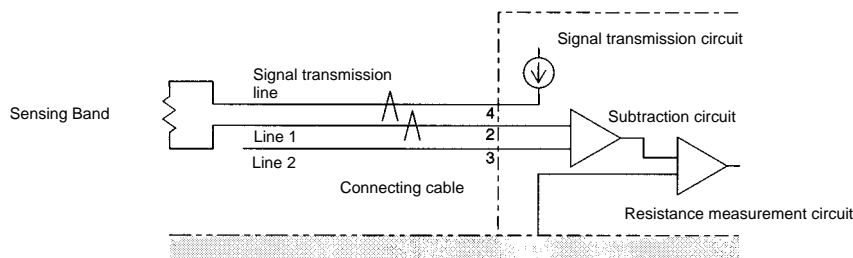

### ■ CHEMICAL RESISTIVITY FOR THE SENSING BAND (REFERENCE VALUES)

Material	F03-16PE	
	Sheath	Core
	Polyethylene	SUS316
Water	A	A
Acetone	C	A
Ammonia	A	A
Ethanol	B	A
Hydrochloric acid	A	C
Hydrogen peroxide solution	A	A
Xylene	B	A
Cyclohexane	C	---
Trichloroethylene	C	A
Toluene	C	B
Phenol	B	A
Butanol	B	---
Fluorine	A	C
Hexane	C	---
Benzene	C	A
Methanol	B	A
Sulfuric acid	C	B
Phosphoric acid	A	B

- Note: 1. A: Not affected at all or only very slightly affected.  
 B: Slightly affected but, depending on the conditions, sufficient for use.  
 C: Affected but may still be used. (Replace the Sensing Band immediately after detection.)
2. In order to prevent secondary fire damage, consider the effect of the atmosphere of the environment and the solution to be detected on the Sensing Band.
3. If the Sensing Band changes shape or color when a liquid is detected, replace the the Sensing Band.

■ CONNECTIONS

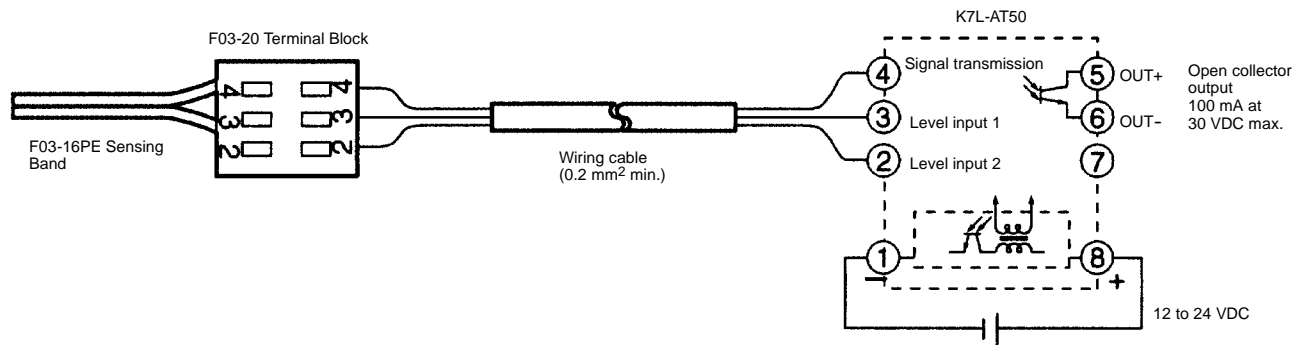

■ CONNECTIONS EXAMPLE

NPN Output

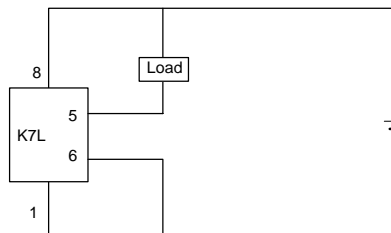

PNP Output

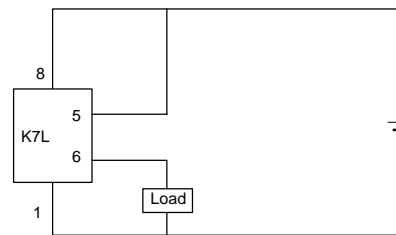

Note: Transistor Output

The transistor output of the K7L is insulated from the internal circuitry by a photocoupler, so the transistor output can be used as both NPN and PNP output.

■ SENSING BAND

Part number	F03-16PE
Appearance	
Structure	
Material	Sheath: Polyethylene Core: Stainless steel SUS316

Note: Specify length (in meter units) when ordering.

When cleaning with a mop, for example, do not make contact with the Sensing Band.

## ■ SENSING BAND STICKER

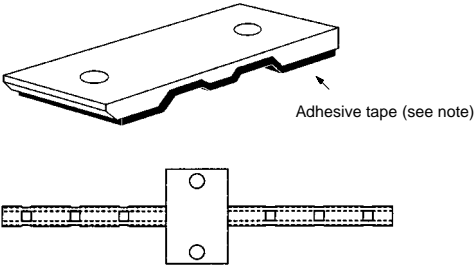
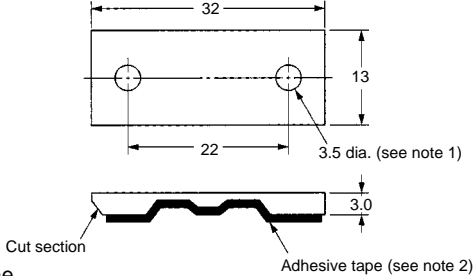
Part number	F03-26PE/F03-26PEN for F03-16PE
Appearance	<p><b>F03-26PE</b></p>  <p>Adhesive tape (see note)</p> <p><b>Note:</b> The adhesive part is on the F03-26PE only.</p>
Structure	 <p>Material: Polyethylene</p> <p><b>Note:</b> 1. The holes are in the F03-26PEN only. 2. The adhesive part is on the F03-26PE only.</p>
Application	<p>An adhesive model and a non-adhesive model are available. If installing the Sensing Band in a place where the adhesive part may peel off due to contact with liquids, use the non-adhesive model and then drive the screws (recommended screws: M3 screws or M3 studs) in the holes.</p> <p>When using, remove the seal and attach onto a smooth surface. When attaching to a concrete floor surface, concrete bond is recommended.</p>

# Dimensions

Unit: mm (inch)

## Liquid Leakage Sensor Amplifier K7L-AT50

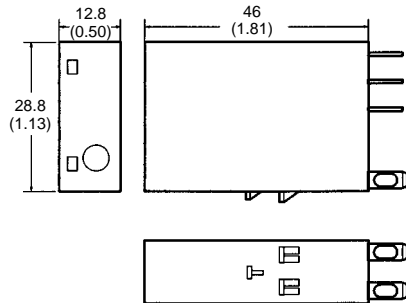

## Terminal Block F03-20

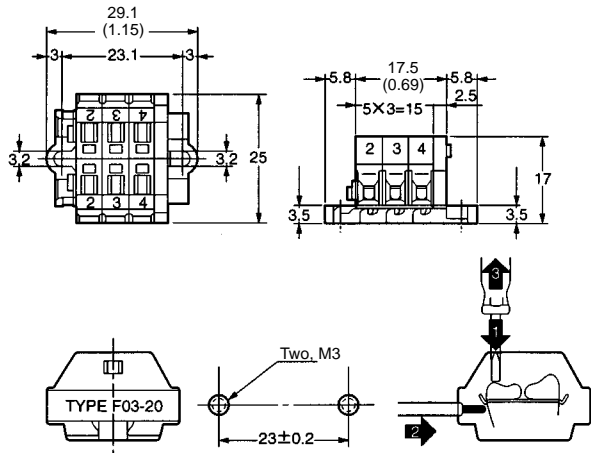

- Locations subject to dust.
- Locations subject to corrosive gases (particularly sulfide and ammonia gases).

## Track-mounted Sockets P2RF-08-E

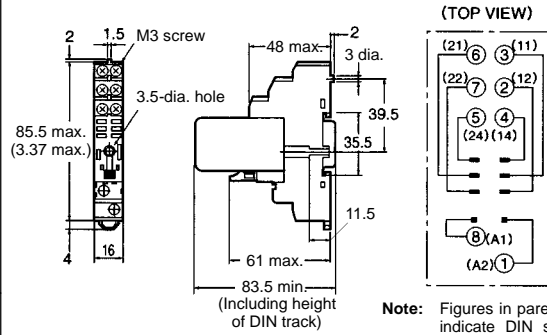

Note: Figures in parentheses indicate DIN standard numbers.

## P2RF-08 (Round terminals can be used.)

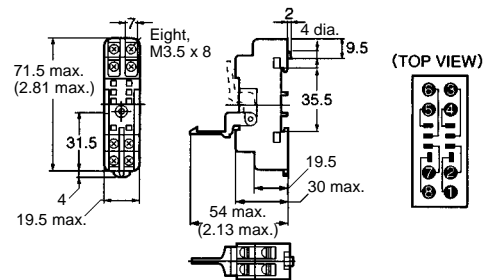

- Outdoors or locations subject to direct sunlight.
- Near devices that generate strong high-frequency noise (e.g., high-frequency welding devices etc.).

## Precautions

### ■ GENERAL PRECAUTIONS

The user must operate the product according to the performance specifications.

Before using the product under conditions which are not described in the manual or applying the product to nuclear control systems, railroad systems, aviation systems, vehicles, combustion systems, medical equipment, amusement machines, safety equipment, and other systems, machines, and equipment that may have a serious influence on lives and property if used improperly, consult your OMRON representative.

Make sure that the ratings and performance characteristics of the product are sufficient for the systems, machines, and equipment, and be sure to provide the systems, machines, and equipment with double safety mechanisms.

### ■ Safety Precautions

Observe the following points to ensure safe operation.

- Be sure to use a power supply voltage within the specified range. Not doing so may result in burning or malfunction.
- Do not use the product in locations subject to flammable gases or combustible objects. Not doing so may result in fire.
- Insert the connection points into Sockets until the connection is locked securely. Not doing so may result in burning or malfunction.
- Do not short-circuit loads connected to output terminals. Doing so may result in burning.
- Be sure to connect the power supply with the correct orientation. Not doing so may result in malfunction.

### ■ CORRECT USE

#### Installation

Attach to a panel of thickness 1 to 5 mm.

Do not install in the following locations.

- Locations subject to shock or vibration.
- Locations where the temperature or humidity lies outside the specified range, or where condensation is likely to occur. (To detect liquids with high impedances, do not use in locations with high humidity.)
- Locations subject to dust.
- Locations subject to corrosive gases (particularly sulfide and ammonia gases).
- Outdoors or locations subject to direct sunlight.
- Near devices that generate strong high-frequency noise (e.g., high-frequency welding devices etc.).

**NOTE: DIMENSIONS SHOWN ARE IN MILLIMETERS. To convert millimeters to inches divide by 25.4.**

**OMRON**<sup>®</sup>  
**OMRON ELECTRONICS, INC.**  
One East Commerce Drive  
Schaumburg, IL 60173  
**1-800-55-OMRON**

**OMRON CANADA, INC.**  
885 Milner Avenue  
Scarborough, Ontario M1B 5V8  
**416-286-6465**